

Bordscheiben für einteilige Kettenrollen
nach Tabelle SK 2850

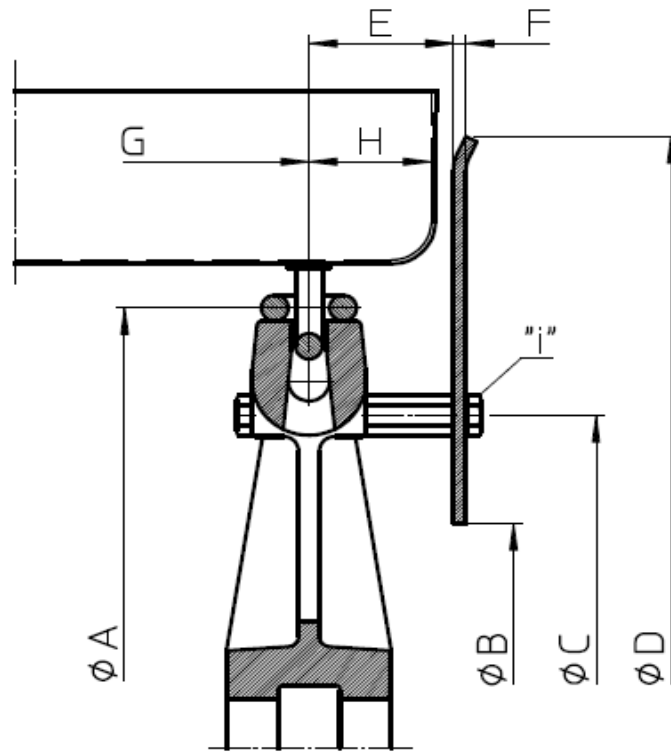

Becherbreite	Kette	A	B	C	Anzahl und Größe "i"		D	E	F	G	H	Gewicht in kg ca.
160	13	500	320	367	4	M 16 x 110	650	46	6	100	30	15
200	13	500	320	367	4	M 16 x 110	650	53	6	125	37,5	16
200	16	500	320	367	4	M 16 x 110	650	53	6	125	37,5	16
250	16	630	430	480	8	M 16 x 130	840	65	8	160	45	29
315	16	630	430	480	8	M 16 x 150	840	77	8	200	57,5	30
400	20	710	480	530	je 8	M 16 x 120 M 16 x 30	980	95	8	250	75	43
500	23	800	540	600	je 8	M 16 x 120 M 16 x 45	1100	115	10	315	92,5	64
630	26	900	620	680	je 8	M 16 x 150 M 16 x 50	1250	140	12	400	115	112
800	30	1000	700	760	je 8	M 16 x 180 M 16 x 60	1380	180	12	500	150	130
1000	36	1250	920	980	je 10	M 20 x 200 M 20 x 80	1700	215	15	630	185	231